

# CATALOGO PROFILI FOTOVOLTAICO













---

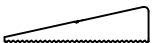
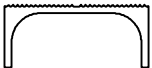

**B.B.C.** S.r.l.  
EXTRUSION













# ELENCO PROFILATI

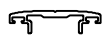

CODICE	SEZIONE	PESO <i>Kg/m</i>	DESCRIZIONE	PG.
DFV0536		1,023	Nodo Architrave	1
DFV0538		1,574	Puntale	1
DFV0539		0,750	Omega	1
DFV0552		0,697	Zeta	1
DFV0553		1,401	Arandela	1
DFV0720		2,368	Cuneo	2
DFV0721		1,785	Pieza	2
DFV0709_SM		0,553	Telaio	2
DFV0710		0,895	Squadretta	2
DFV1699		1,163	Profilo strutturale impianto a tetto	2
DFV0911		1,148	Profilo strutturale	3
DFV0912_SM		1,310	Profilo strutturale con portacavi	3
DFV0913		0,794	Profilo binario	3
DFV0914		0,575	Staffa laterale	3

# ELENCO PROFILATI

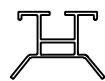

CODICE	SEZIONE	PESO <i>Kg/m</i>	DESCRIZIONE	PG.
DFV1222		0,624	Staffa laterale	3
DFV0915		0,558	Pressore centrale	3
BST1515		0,675	Piatto 50 x 5	4
BST0917		1,282	Prof. T 50 x 50	4
BST0918_SM		0,705	Elle 60 x 30	4
DFV0919		0,377	Pressore	4
DFV0920		1,138	Supporto pannelli	4
DFV0921_SM		0,213	Cursore slitta	4
DFV0952		0,499	Guida	5
DFV0955		0,957	Profilo strutturale	5
DFV0975		0,715	Profilo di sostegno	5
DFV1229		1,109	Profilo di sostegno	5
DFV1312		0,998	Traverso portacavi	5
DFV1661		0,992	Profilo strutturale	5

Profili standard

Da pg. 6

# ELENCO PROFILATI

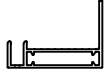

CODICE	SEZIONE	PESO <i>Kg/m</i>	DESCRIZIONE	PG.
DFV2497		0,411	Telaio 29.8 x 41.6	2

Da pg. 6

NODO ARCHITRAVE    DFV0536    1,023 Kg/ml

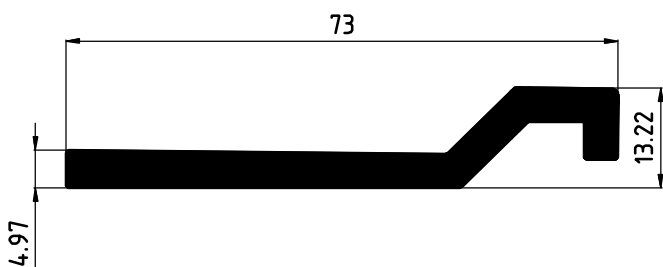

OMEGA    DFV0539    0,750 Kg/ml

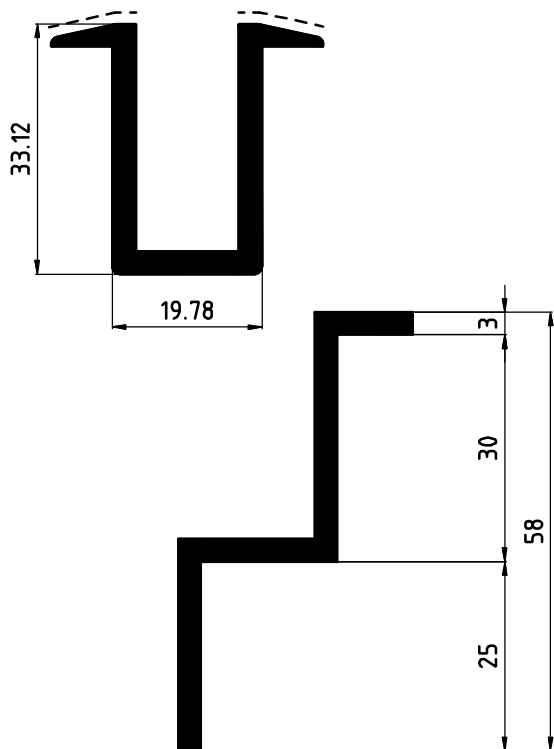

ZETA    DFV0552    0,697 Kg/ml

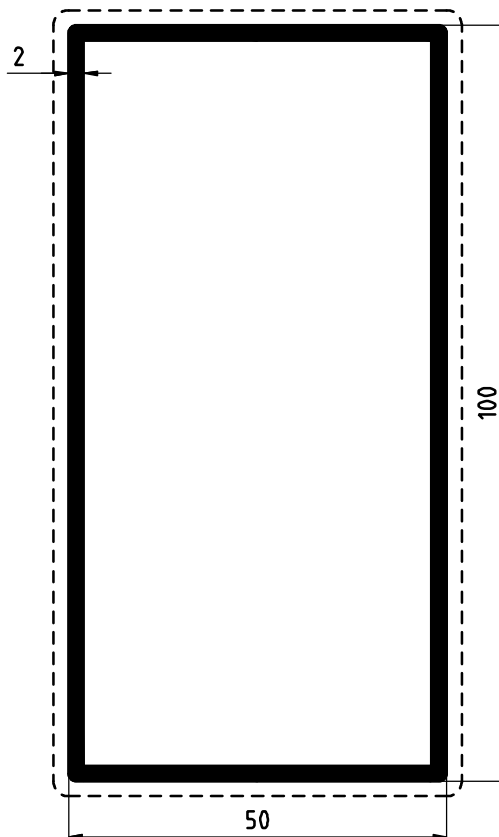

PUNTALE    DFV0538    1,574 Kg/ml

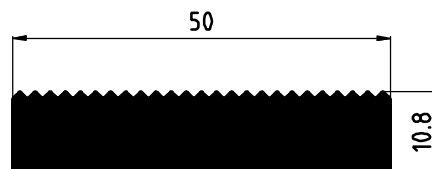

ARANDELA    DFV0553    1,401 Kg/ml

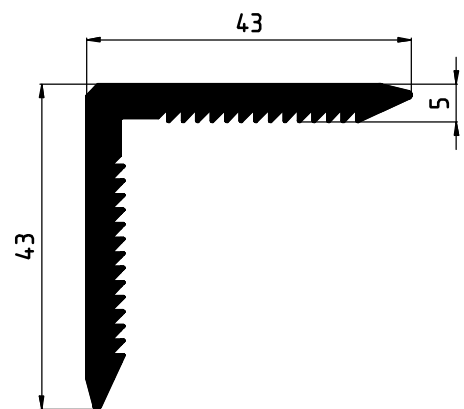
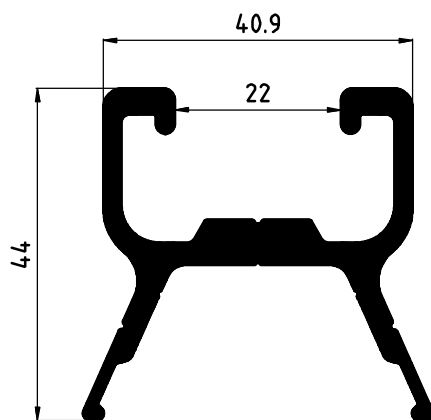
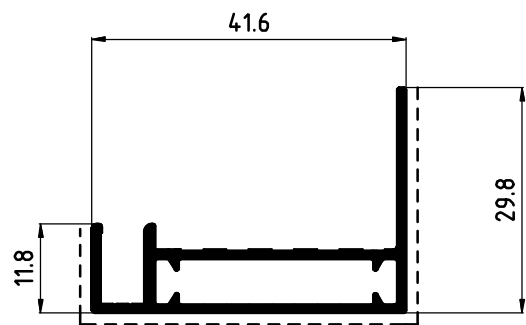
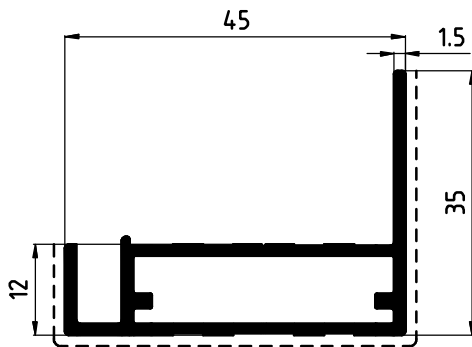
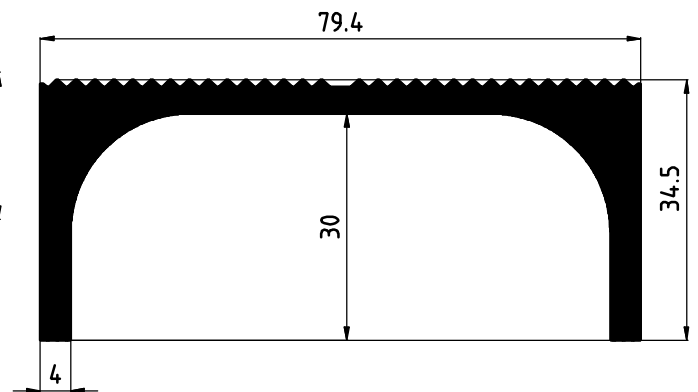
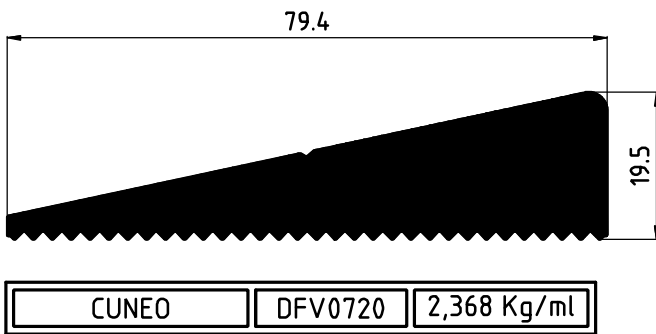

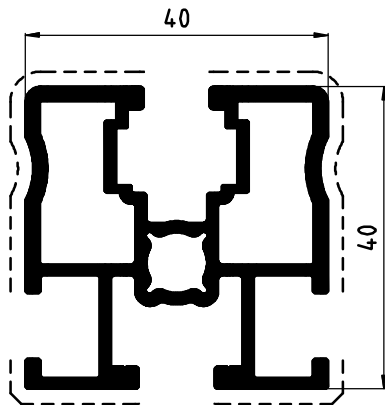

PROF. STRUTTURALE    DFV0911    1,148 Kg/ml

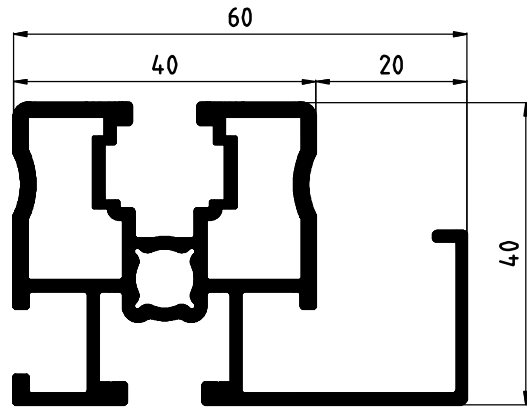

PROF. STRUTTURALE    DFV0912\_SM    1,310 Kg/ml

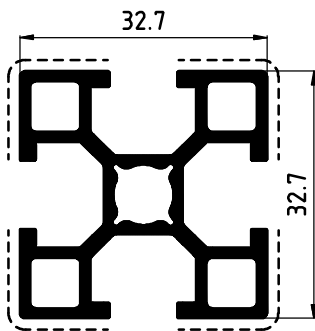

PROFILO BINARIO    DFV0913    0,794 Kg/ml

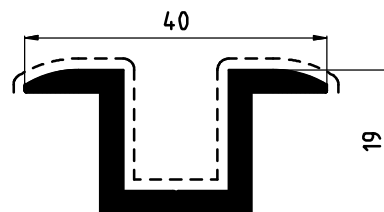

PRESSORE CENTRALE    DFV0915    0,558 Kg/ml

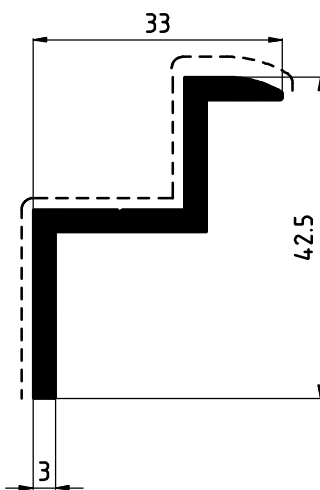

STAFFA LATERALE    DFV0914    0,575 Kg/ml

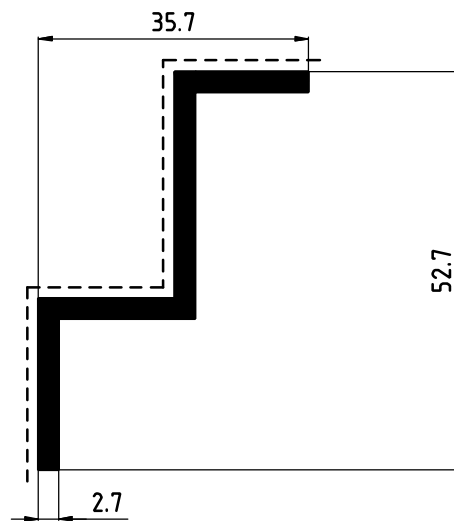

STAFFA LATERALE    DFV1222    0,624 Kg/ml

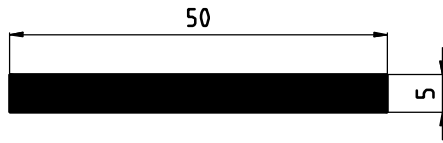

PIATTO	BST1515	0,675 Kg/ml
--------	---------	-------------

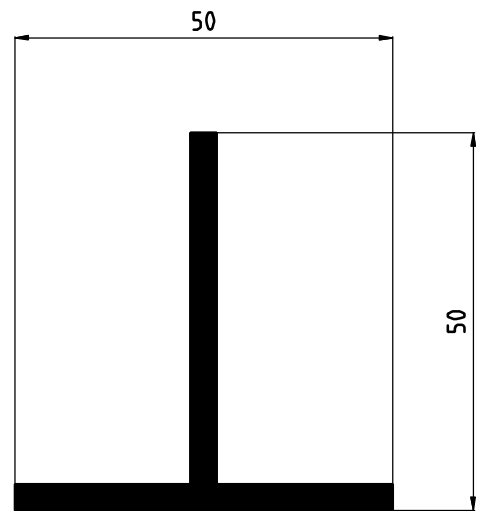

PROFILO T	BST0917	1,282 Kg/ml
-----------	---------	-------------

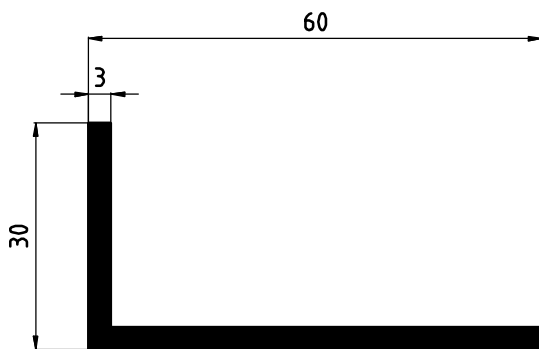

ELLE	BST0918_SM	0,705 Kg/ml
------	------------	-------------

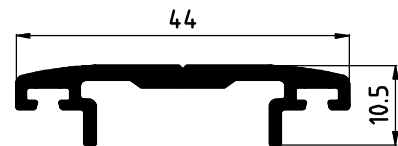

PRESSORE	DFV0919	0,377 Kg/ml
----------	---------	-------------

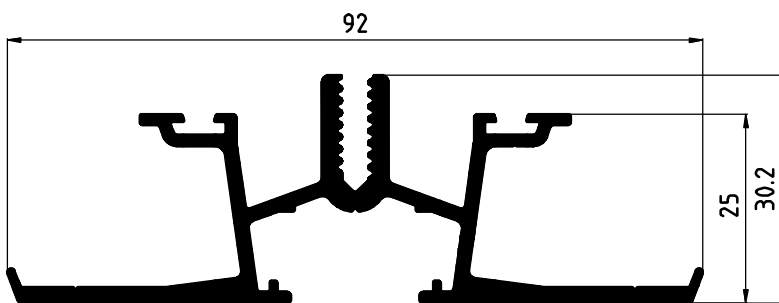

SUPPORTO PANNELLI	DFV0920	1,138 Kg/ml
-------------------	---------	-------------

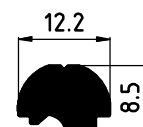

CURSORE SLITTA	DFV0921_SM	0,213 Kg/ml
----------------	------------	-------------



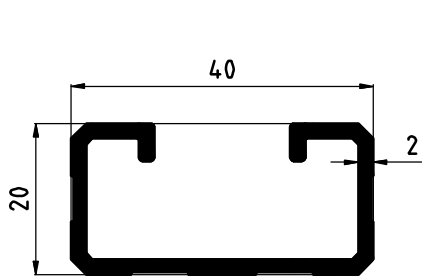

GUIDA

DFV0952

0,499 Kg/ml

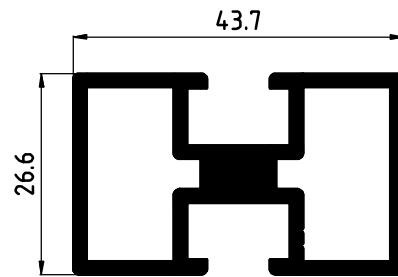

PROFILO STRUTTURALE

DFV1661

0,992 Kg/ml

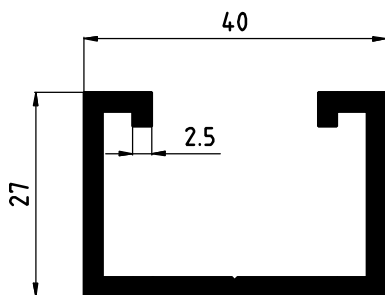

PROFILO DI SOSTEGNO

DFV0975

0,715 Kg/ml

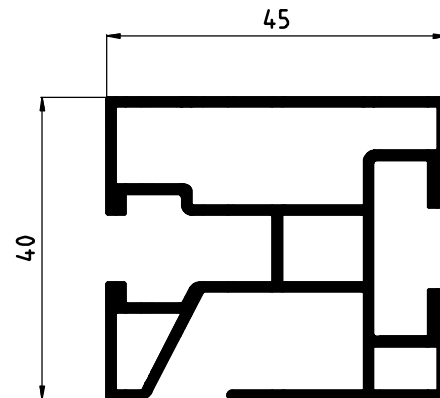

PROFILO STRUTTURALE

DFV0955

0,957 Kg/ml

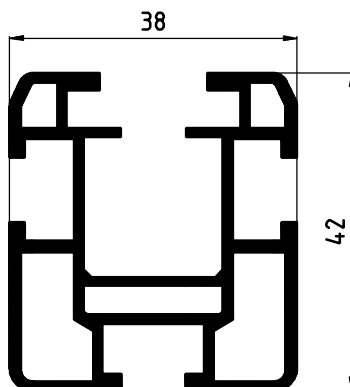

TRAVERSO PORTACAVI

DFV1312

0,998 Kg/ml

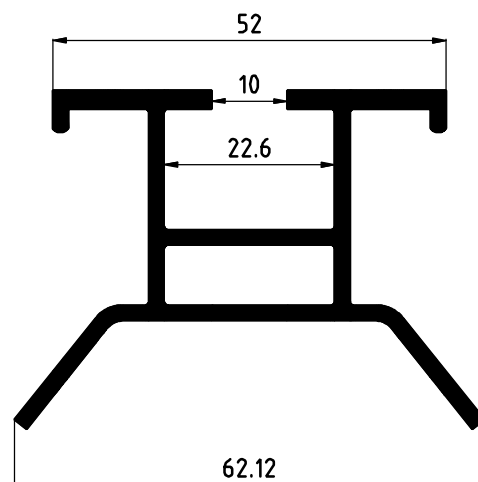

PROFILO STRUTTURALE

DFV1229

1,109 Kg/ml

# TUBI TONDI

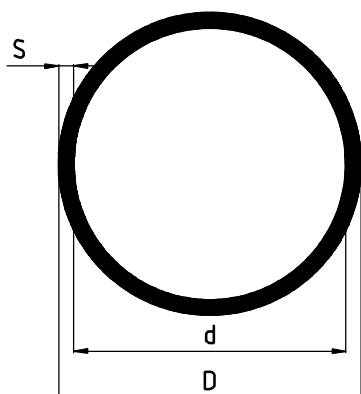

D	d	S	Kg/m	Codice profilo
5.7	3.8	1	0,038	BST0344
8	6.2	0.9	0,054	BST0343
10	8	1	0,076	BST1429
13	10	1.5	0,146	BST0225
13	10.4	1.3	0,129	BST1180
15	12	1.5	0,172	BST0177
18	15	1.5	0,210	BST0254
25	22	1.5	0,299	BST0178
28	26	1	0,229	BST0611
30	27	1.5	0,362	BST0179
35	31	2	0,560	BST0517
35	33	1.2	0,344	BST0612
35	33	1	0,288	BST0711
40	36	2	0,645	BST0516
48	40	4	1,493	BST1358
50	42	4	1,560	BST1357
50	46	2	0,814	BST0521
60	58	1	0,500	BST0807
60	57	1.5	0,744	BST0646
80	78	1	0,670	BST0645
80	77	1.5	0,999	BST0727
100	98	1	0,840	BST0728
100	97.6	1.2	1,006	BST1123
133	131	1	1,120	BST0085

# TUBI QUADRI

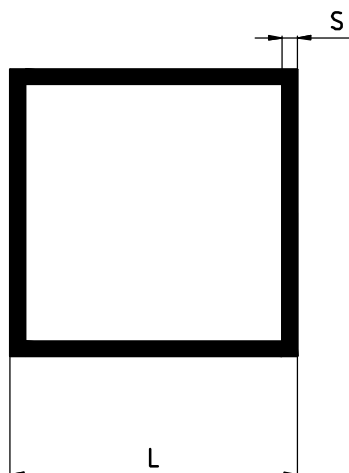

L	S	Kg/m	Codice profilo
7.7	1,4	0,095	BST0712
10	1	0,097	BST0464
20	1.5	0,300	BST0180
25	1.5	0,381	BST0429
30	2	0,605	BST1032
40	2	0,820	BST0384
45	1.5	0,705	BST0181
50	2	1,037	BST0182
50	1.5	0,786	BST0474
60	1.5	0,948	BST0183

# TUBI RETTANGOLARI

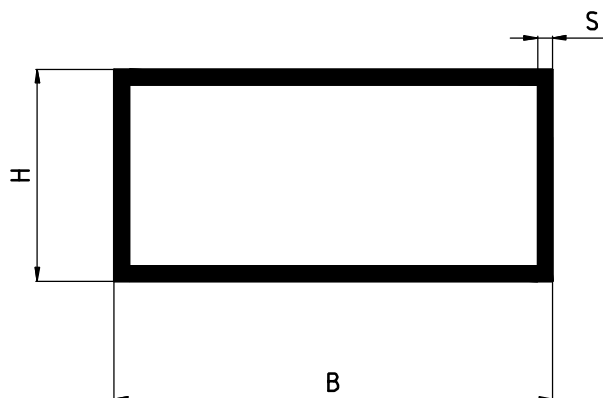

B	H	S	Kg/m	Codice profilo
15	10	1.5	0,178	BST1658
20	10	1.5	0,219	BST0386
30	15	2	0,443	BST0184
40	15	1.5	0,421	BST0228
40	20	1.5	0,462	BST0229
40	20	2	0,605	BST0387
48	25	0.8	0,308	BST0332
50	15	1.5	0,502	BST0185
50	40	2	0,928	BST1697
60	20	1.5	0,638	BST0186
80	40	1.5	0,948	BST0187
80	20	2	1,037	BST0388
100	20	2	1,253	BST0385
100	20	1.5	0,948	BST1051
100	40	1.5	1,110	BST1029
100	50	2	1,574	BST0538
120	20	1.5	1,110	BST0188

# PROFILI A L

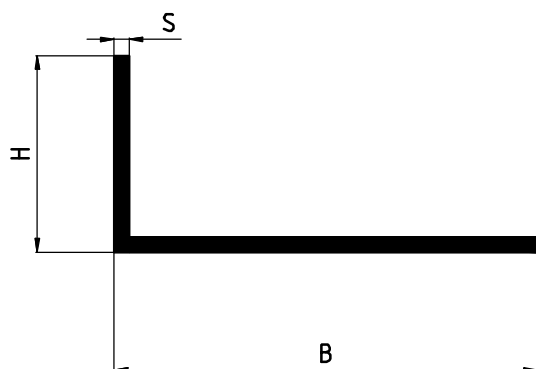

B	H	S	Kg/m	Codice profilo
20	10	2	0,151	BST0494
40	20	2	0,313	BST1030
60	20	2	0,421	BST1031
60	30	4	0,929	BST1354
80	20	1.5	0,399	BST0189
100	20	1.5	0,480	BST0190

# ANGOLARI A LATI UGUALI

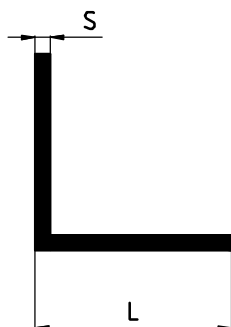

L	S	Kg/m	Codice profilo
20	1.5	0,156	BST0234
30	2	0,313	BST0929
40	5	1,012	BST0457
50	1.5	0,399	BST0191

# PROFILI A U

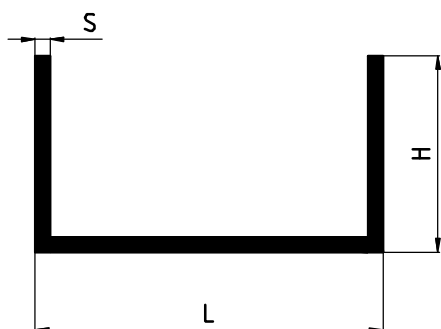

L	H	S	Kg/m	Codice profilo
30	10	2	0,248	BST0897
32	12	2	0,302	BST0493
50	20	1.5	0,352	BST0192
60	20	1.5	0,393	BST0193
80	20	1.5	0,474	BST0194
91	37.5	1.5	0,660	BST0870
100	20	1.5	0,555	BST0195
120	20	1.3	0,553	BST0042
120	20	2	0,846	BST0583

# PROFILATI T

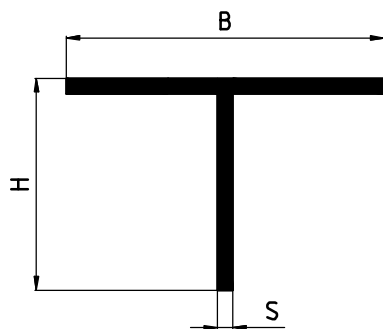

B	H	S	Kg/m	Codice profilo
30	18	1	0,127	BST0113
50	29	4	0,810	BST1226
50	50	5	1,282	BST0917



# BARRE TONDE

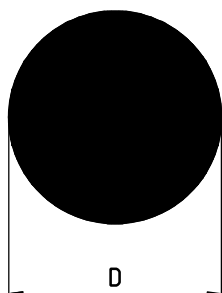

D	Kg/m	Codice profilo
8	0,135	BST0253
12	0,305	BST0527
6	0,760	BST0577

# BARRE PIATTE

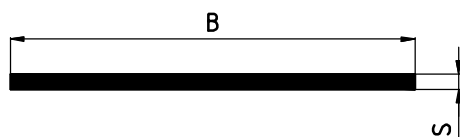

B	S	Kg/m	Codice profilo
6	3	0,049	BST0490
10	3	0,081	BST0510
15	3	0,121	BST1330
20	2	0,108	BST0320
30	2	0,162	BST0321
40	2	0,216	BST0930
40	3	0,324	BST0983
40	10	1,080	BST0640
50	2	0,270	BST0383
50	5	0,675	BST1515
80	2	0,432	BST0766